

Underground rainwater tanks

from 1,470 to 7,500 liters

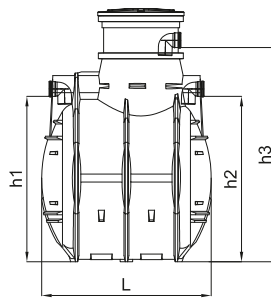

Rainwater tank 1470 l

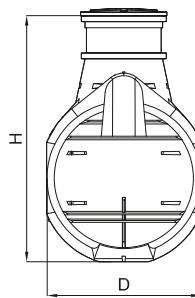

	inlet diameter (mm)	inlet height (mm)	outlet height h1 (mm)	total height H (mm)	length L (mm)	Width D (mm)
tank without filter	110	h2 / 1320	1290	1960	1356	1240
tank with filter	110	h3 / 1720	1290	1960	1356	1240

Rainwater tank 2000 l

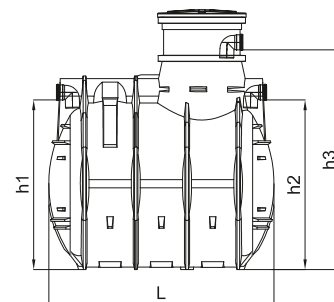
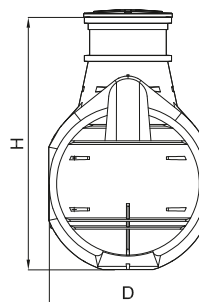

	inlet diameter (mm)	inlet height (mm)	outlet height h1 (mm)	total height H (mm)	length L (mm)	Width D (mm)
tank without filter	110	h2 / 1320	1290	1960	1756	1240
tank with filter	110	h3 / 1720	1290	1960	1756	1240

Rainwater tank 2500 l

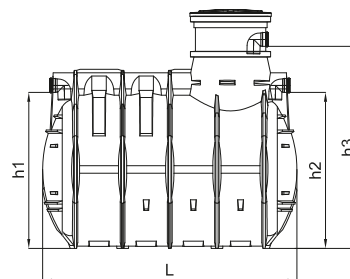
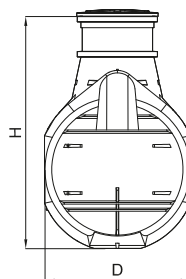

	inlet diameter (mm)	inlet height (mm)	outlet height h1 (mm)	total height H (mm)	length L (mm)	Width D (mm)
tank without filter	110	h2 / 1320	1290	1960	2156	1240
tank with filter	110	h3 / 1720	1290	1960	2156	1240

Rainwater tank 3750 l

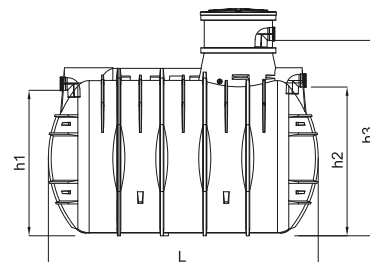
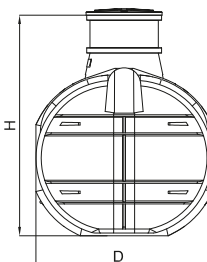

	inlet diameter (mm)	inlet height (mm)	outlet height h1 (mm)	total height H (mm)	length L (mm)	Width D (mm)
tank without filter	110	h2 / 1350	1320	2000	2450	1600
tank with filter	110	h3 / 1770	1320	2000	2450	1600

It is possible to connect tanks to obtain larger capacities.

Rainwater tank 5250 l

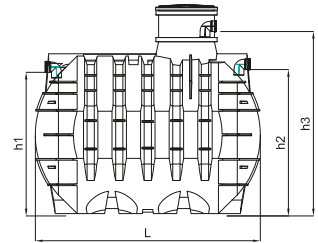
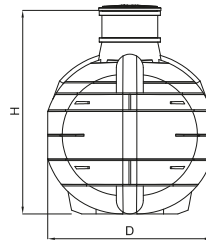

	inlet diameter (mm)	inlet height (mm)	outlet height h1 (mm)	total height H (mm)	length L (mm)	Width D (mm)
tank without filter	110	h2 / 1600	1570	2250	2500	1825
tank with filter	110	h3 / 2020	1570	2250	2500	1825

Rainwater tank 6000 l

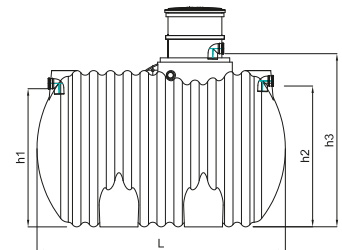
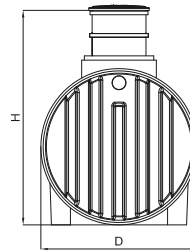

	inlet diameter (mm)	inlet height (mm)	outlet height h1 (mm)	total height H (mm)	length L (mm)	Width D (mm)
tank without filter	110	h2 / 1610	1580	2460	2840	1790
tank with filter	110	h3 / 1950	1580	2460	2840	1790

Rainwater tank 7500 l

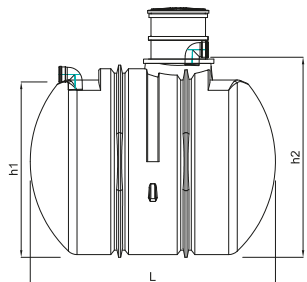
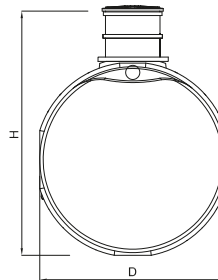

	inlet diameter (mm)	inlet height (mm)	outlet height h1 (mm)	total height H (mm)	length L (mm)	Width D (mm)
tank without filter	160	2230	1900	2640	2770	2100
tank with filter	160	2230	1900	2640	2770	2100

Rainwater tank 2400 l GARDEN

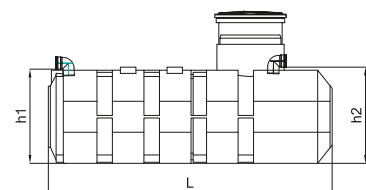
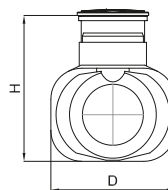

	inlet diameter (mm)	inlet height (mm)	outlet height h1 (mm)	total height H (mm)	length L (mm)	Width D (mm)
tank without filter	110	h2 / 930	770	1410	2745	1200

Rainwater tank 3500 l GARDEN

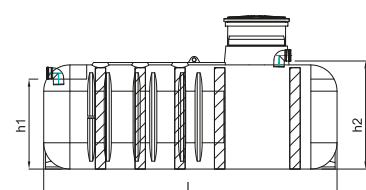
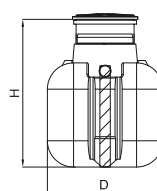

	inlet diameter (mm)	inlet height (mm)	outlet height h1 (mm)	total height H (mm)	length L (mm)	Width D (mm)
tank without filter	110	h2 / 950	1140	1560	3100	1220

It is possible to connect tanks to obtain larger capacities.

Additional accessories

Fixed and telescopic extensions



BASIC cover

The standard manhole cover of a sewage treatment plant, pumping station or separator is available in green or black

PREMIUM cover

It is characterized by a modern look thanks to its flat design and increased load resistance

KAMELEON cover

Thanks to a special recess, it allows the cover to be adapted to the environment, e.g. grass, stones, bark, etc. and facilitates mowing the lawn.

TOP MULTI-TECH

Multistage submersible pump

Automatic switching on and off



Performance data

Efficiency up to 120 l / min (7.2 m³ / h)

Lifting height: 42 m

Cut-in pressure: 1.5 bar

Application

TOP MULTI-TECH pumps are recommended for pumping clean water and liquids that are not chemically aggressive to the materials of the pump.

Due to their high efficiency and reliability, they are suitable for use in applications such as the supply of water from tanks, manholes or relatively deep wells, for collecting rainwater from tanks into water gardens, or for use in irrigation systems, etc.

An internal electronic device automatically starts or stops the pump when the valve is opened or closed.

Infiltration tunnels

Tunnel drainage is ideal for draining excess rainwater on the plot. The main benefits of the use of infiltration tunnels include uncomplicated and quick assembly, the possibility of connecting modules into lines of any length, light structure and the possibility of building an underground system, thanks to which we can rationally manage the area.

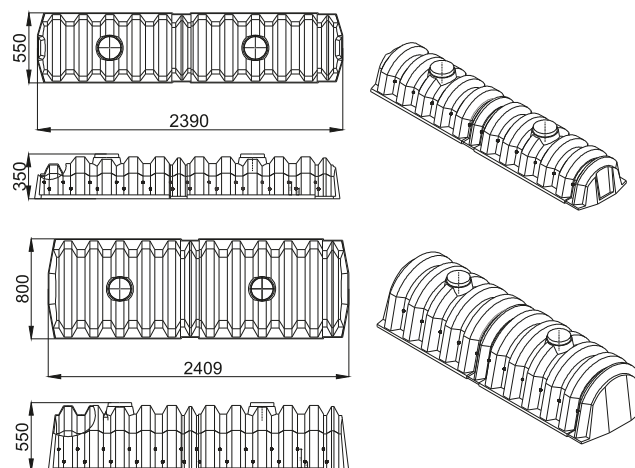

Absorbent well 850 l

